



SOLID RIDGE METAL LLC

Manufacturer Of Quality Metal Roofing

Product Catalog



METAL ROOFING, SIDING, & SUPPLIES

- Residential • Agricultural • Commercial



Buy Direct & **SAVE!**

- **Superior Service**
Same Day or Next Day Order Turnaround
 —Picked Up or Shipped to your Site
- **Superior Value**
Buy Factory Direct—No Middleman
- **Excellent Quality**

Solid Ridge Metal LLC is locally owned and operated in central PA. High attention to detail and quality is part of our daily routine. Whether you are in need of metal panels, lumber, fasteners, trim, or accessories, they can all be found at our manufacturing facility.



Table of Contents

Metal Roofing & Siding	3
Screws.	4-5
Sealers.	6
Ventilation	7
Pipe Flashing.	8
Miscellaneous	9
Underlayment	10-11
Door Accessories	12-15
Snow Guards	16

- Residential
- Agricultural
- Commercial

Solid Ridge Metal Roofing & Siding

Solid Ridge metal roofing and siding offers a look that can complement many building styles. With clean lines and coordinating trim, your neighbors will be impressed! Enjoy many years of maintenance-free durability with Solid Ridge metal!

Warranty

Every painted exterior panel is backed with a 40-year limited warranty. (Details available upon request.)

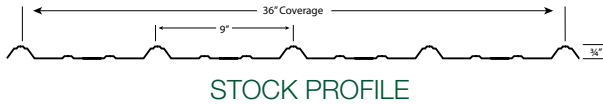

Deluxe Super Rib 100™

Unsurpassed in Durability & Quality

- 28-gauge steel
- Beckry-Tech Finish

VARIETY—COLOR & TEXTURE

- 32 color options to choose from!
 - 21 in the highly durable Polyester Cool Series
 - 11 in the Textured Series

Premium AZ-50™

Excellent Durability

- 28-gauge steel
- Sherwin Williams finish

VARIETY—COLOR & TEXTURE

- 28 color options to choose from!
 - 21 in Weather XL Silicone-Modified Polyester
 - 7 in the Textured Series

Quality & Integrity

They say beauty is only skin deep... But rest assured, not only is Solid Ridge metal beautiful—it is also a product of deep integrity, from the inside out! Starting with premium 28-gauge steel, the metal substrate is also of the strongest and highest quality. Finally, Solid Ridge metal roofing and siding is coated with a finish that provides an optimum balance of hardness and flexibility, along with corrosion, heat, and UV resistance.

7 REASONS WHY

Deluxe Super RIB 100™ is Better!

• BARE STEEL

Super Rib 100 is manufactured from only 28 gauge, 80,000 minimum PSI bare steel with a minimum .0157 thickness before paint to assure you of a thick, strong panel.

• GALVANIZATION (2 layers)

Super Rib 100 has up to 10 oz. of zinc protection, resulting in up to 67% more corrosion protection.

• ZINC PRE-TREATMENT

(2 layers) Prepares the surface for paint while adding additional corrosion resistance.

• SEALER COAT

(2 layers) Seals the zinc pre-treatment and smooths the surface to receive the paint.

• THICK PRIMER COAT

(2 layers) Prepares the surface for consistent color application while adding even more corrosion protection.

• BACKER COAT

Full coat backer in off-white for consistency inside the building.

• TOP COAT

Premium HDPE (Highly Durable Polyester) Cool Roof Colors with excellent color retention & durability—32 colors available.

CONTACT US FOR YOUR METAL ROOFING & SIDING NEEDS!

Phone 814-349-5050 Fax 814-349-5051

SCREWS

Strong V-Neck Head

Provides superior installation strength.



1/2" EPDM Bonded Washer

Compare us. We don't compromise on washer size, and achieve a better seal.



#10 Hi-Lo Thread

For easy drilling and better holding power.



Reduced Point

Reduces trapped steel shavings.



Fastgrip™ Mini-Driller™

#10 Hi-Lo Mini-Driller™

- Mechanical Galvanized
- Hi-Lo Threads
- Galvanized 1/2" OD EPDM Washer
- Fastens Metal to Wood
- 1/4" Hex Head
- RP Drill Point
- Three Lengths in Stock
 - 1"
 - 1 1/2"
 - 2"

Also available in T-17 Drill Point

Wet Painted

Long-lasting paint application stays on and keeps its color.

Mechanical Zinc Galvanized Plating

Average 1 mil, to protect against corrosion.

True-to-Size Head

Consistent head size allows use of standard nut setter.

1022 Carbon Steel

Preferred by builders for superior performance.

250 Per Bag

ZXL™ Lifetime Screw

#10 Direct Seal ZXL

- Long Life Zinc Alloy Cap Head
- Lifetime Warranty Against Red Rust Corrosion
- M-Bit Mini Drill Point Excels in Penetrating Multi Thickness Materials
- Ideal for Installation into Dimensional Lumber
- Two Lengths in Stock—1 1/2" & 2"
- EPDM Seal Washer



ZAMAC 5 zinc aluminum alloy molded head—not a cap!

EPDM undercut rubber washer, for most efficient seal

2.5 mils of powder protection



Micro bit

MetalGrip™ Stitch

MetalGrip™ Stitch w/Washer



- Mechanical Galvanized
- Self-drilling #1
- Galvanized 15mm EPDM Washer
- Fastens Metal to Metal
- 5/16" Hex Head
- 14 x 7/8" Stitch

LoGrip™

Use for Interior Liner Panel



- T25 Star drive
- Low Profile
- Mechanical Galvanized
- Hi-Lo Threads
- Fastens Metal to Wood
- White in Stock
- 1" With or Without Washer

Dekfast Washers



Recommended for Use with Polycarbonate Skylight Panels or Side Light Panels

- Poly washer, Gray

• Residential • Agricultural • Commercial

Flat Head Deck Screw



T25 Star Drive

- T-17 Point
 - ACQ Approved
 - 1500 Hour Salt Spray Coating
 - Easy Bucket Storage
 - Driver Bits Available
- #9 x 2" — 3,000 Pcs/Bucket
 #9 x 2 1/2" — 2,500 Pcs/Bucket
 #10 x 3" — 1,500 Pcs/Bucket
 #10 x 3 1/2" — 1,000 Pcs/Bucket
 #10 x 4" — 1,000 Pcs/Bucket
 #10 x 5" — 500 Pcs/Bucket

Blue Concrete Screw

Slotted Hex Head Drive

- Carbon Steel Masonry Screw
 - TFL Corrosion-Resistant Coating
 - Medium Duty Application
 - Concrete, Hollow Core or Solid Block, Brick
 - Drill Bit Included per box of 100
- 1/4 x 1 3/4" — 100 Per Box/1,000 Per Carton
 1/4 x 2 1/4" — 100 Per Box/1,000 Per Carton
 1/4 x 2 3/4" — 100 Per Box/1,000 Per Carton
 1/4 x 3 1/4" — 100 Per Box/1,000 Per Carton



FrameGrip™ Structural Screw



FrameGrip™ Advantage

- Lag Screw Alternative
 - U Threads
 - Type 17 Point
 - Saw Thread
 - T30 or T40 star drive
 - Star drive bit included with bucket
 - Compatible w treated lumber
 - Sold by the Piece or by the bucket
- 5/16 x 3" — T30 star drive; 500 Pcs/Bucket
 5/16 x 4" — T30 star drive; 500 Pcs/Bucket
 5/16 x 5" — T30 star drive; 500 Pcs/Bucket
 5/16 x 6" — T30 star drive; 250 Pcs/Bucket
 3/8 x 8" — T40 star drive; 150 Pcs/Bucket

Driver Bits



- #2 Square
- 1/4 Hex Nut Setter (Magnetic) 1-7/8"
- 5/16 Hex Nut Setter (Magnetic) 1-7/8"
- #2 Phillips
- T25 Star Drive

Spring Nut Setters



Work great with ZXL Lifetime screws

- Spring with ball bearing secures the screw during installation
- 1/4 Spring nut setter 2-9/16"
 5/16 Spring nut setter 2-9/16"

SEALERS

QuickLath™

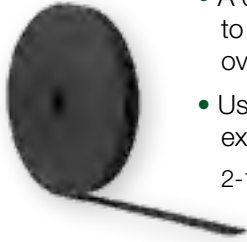

The Better Way!

- A quick and easy spacer material to use when installing a metal roof over existing shingles.
 - Use multiple layers to even out existing roof inconsistencies.
- 2-1/2" w x 150' Roll

Butyl Tape



Reliable and Superior Seal!

Protect and seal trims, seams and vents on metal roofs with long-lasting protection against the elements.

- Easily adheres to multiple materials
 - Greater cohesive strength
 - Superior adhesive strength
 - Withstands extreme roof temperature
 - Cold flow resistant
- 1/2" x 3/32" x 50'

Dekstrip™



Expandable Edge Flashing

- Stretches to any shape, seals, and stays.
- Gray TPE has a continuous service temperature range of -58° to +240° F
- Serpentine edges stretch up to 25% for added length
- Paintable after installation
- Expands around almost any profile—ideal for square ducts, chimneys and skylights
- Absorbs vibration and handles expansion
- Sold by the foot
9" Dekstrip: 9" w

Closure Strips



3/4" High Rib Profile

3/4" High Rib Outer w/glue;
36" L x 1" W

3/4" High Rib Inner w/glue;
36" L x 1" W

Expanding Foam Sealant

Ensure a Weather Tight Seal!

Emseal® is a self-adhering, flexible foam sealant which expands to fill contours and gaps. Use Emseal® to seal out dust, air, wind-driven snow and moisture through joint details in metal buildings and roofs. Suitable for use against metal, plastic, wood, concrete and other common metal building materials. Emseal® expanding sealant is UV-stable and will not dry out and become hard or brittle. The Expanding Foam Sealant maintains a seal during thermal expansion and contraction of building panels. The sealant has a self-adhesive on one side.



- UV stable
 - Will not dry out or become hard and brittle
 - Self-adhering
 - Highly resistant to bugs and vermin
 - Conforms to contours and fills gaps
 - Good thermal and sound insulator
- 1" w 19.68'/roll

• Residential • Agricultural • Commercial

FastVent™ Plus

Metal Roofing Ridge Vent

FastVent™ Plus provides ventilation and uniform air flow for the proper maintenance of metal roofs. Uniquely engineered breathable closure strips eliminate any leak path into the ridge area by completely sealing against the panel profile. This form-fit reduces wind-driven rain problems to a minimum. Closed cell polyethylene completely surrounds the open-cell venting foam.



- Sold by the piece

FastVent™ Plus AG Panel 1-3/4" x 3' L



ProfileVent™ Rolls

Notched Ridge Vent

- Strong and Durable
 - Modified Polyester
 - Non-woven, non-wicking
 - Fiber based matting
 - Designed for specific metal roofing profiles
- 3" wide x 50' Roll



FloVent® R115

Metal Roofing Ridge Vent

FloVent® is a simple solution which easily installs on varying roof profiles. Protect your building and prolong the life of your roof. The foam construction prevents weather element damage.



Can be installed on the ridge cap or on the roof

- Fits many profiles
 - Increases the longevity of metal roofing
 - Contractor friendly
 - Easy installation with adhesive strip
 - Can be installed on the ridge cap or on the roof
 - Fire retardant & UV stable
- 1 1/2" W x 20' L

Flex-O-Vent™

Universal Venting Material

Marco's Flex-O-Vent™ Universal Venting Material vents, protects and lasts like no other. Its specially formulated polyester, manufactured from recycled material, prevents moisture absorption and holds together to help keep out pests. Flex-O-Vent is also extremely durable, flame-resistant, clog-resistant, and tear-resistant.

Flex-O-Vent is not only an economical choice, it's a long-term solution that provides plenty of cooling air flow, which is vital to meet building codes, reduce utility costs, and minimize long-term building damage caused by improper ventilation.



- Won't absorb moisture, which can freeze and block all ventilation
 - Proprietary adhesive for superior hold
 - Easy, one-person installation
 - Easily cut with scissors or utility knife
 - 40-year limited warranty
- 1" x 2" x 20' L



PIPE FLASHING

Metal Roof Boots



Easy to Work With!

Metal Roof Boots that give long lasting performance from a proven leader in the industry. DEKS roof boots are easy to install and provide a cone design that conforms easily to a range of roof pitches. Clearly marked cutting grooves make it easy to size correctly.

- Available in Low or High temperature resistance
 - Colors: Black, Gray, Dark Blue, White, Brown, Bright Red, Dark Green (Hi Temp only in gray)
- #3: 1/4" to 5"
#5: 4-1/4" to 7-3/4"
#8: 7" to 13"

Round Base Retrofit



- Sold by the piece
- #1: 3/4" to 2-3/4"
#2: 2" to 7-1/4"

Square Base Extreme Angle



- Sold by the piece
- 1/4" - 5-3/4"
Available in black only

SKYLIGHT PANELS

SunSky® Corrugated Polycarbonate Skylight and Sidelight Panels



SunSky® corrugated polycarbonate panels stand up to punishing exterior applications and offer multiple advantages over traditional fiberglass corrugated panels. SunSky provides up to 20 times greater impact resistance, warranted protection against yellowing, excellent load ratings, and the highest resistance to wind uplift—outstanding properties confirmed by independent laboratory tests and in installations worldwide since 1984.

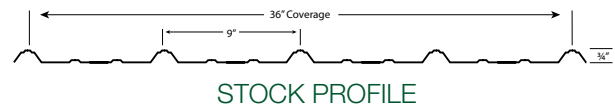

MAIN BENEFITS

- Virtually unbreakable
- High transmission of natural daylight
- Retains optical clarity over time
- Engineered to stay tough over a wide temperature range (-40°F to 212°F)
- Easily and safely installed
- 10 year limited warranty (loss of light transmitting capability; damage due to hail)
- Hail and wind resistant (FBC approved)
- 100% UV protection
- Clear in stock

TYPICAL APPLICATIONS

- Skylights for corrugated metal roofs
- Sidelights • Roofing

• Residential • Agricultural • Commercial

Wedge Anchors

Carbon Steel, Zinc-Plated



- Creates a secure anchor as wedge expands.
 - Ideal to anchor objects in solid concrete or grout-filled concrete masonry.
 - One-piece grip ensures uniform holding capacity that increases as tension is applied.
- 3/8" x 3" 3/8" x 3-3/4"
 1/2" x 2-3/4" . . . 1/2" x 4-1/4" . . . 1/2" x 5-1/2"
 5/8" x 4-1/2" . . . 5/8" x 6"
 3/4" x 5-1/2" . . . 3/4" x 7" 3/4" x 10"

Touch-Up Paint

For Metal Roofing



- Use for quick fixes to provide long-lasting and reliable cover up of small scratches.
- 3 year shelf life
- Allows quick and easy touch-up
- Available in pen or spray can



Trim Nails—For Trim and Fascia

- Painted Stainless Steel
- 1 1/4" Long; 1 lb. per box



Post Foundation Anchor System



Easy and Quick to Install

- Galvanized or hot dipped galvanized* versions
 - Use with concrete applications
 - Low cost
 - Stronger than rebar
- Galvanized 6-5/8" h x 3" w
 Hot Dipped Galvanized 6-5/8" h x 3" w

WeatherMaster X-TREME Foam™



- Sold by the Piece
- Multipurpose Straw Foam
 12 oz can
- Window & Door Straw Foam
 12 oz can
- Fire Block Straw Foam
 12 oz can

WeatherMaster™ Metal Roof Sealant



Permanent Flexibility—Won't Crack

- Extrudes down to 0°F
- Unbeatable adhesion to Kynar™
- Ultra low VOC
- Green build approved
- UV resistant
- Fills gaps
- Available in clear or colors

CondenStop®

An Affordable & High-Capacity Moisture Absorption Solution of Market-Leading Quality

For roofing panel manufacturers and suppliers, contractors and storage owners who need to protect their roofs, investments and assets from the hazards of naturally occurring condensation. Certified by international research institutions to outperform generic products by 20-60%, the unique benefits of CondenStop® are recognized by our many global clients who use millions of square meters each year.

Superior Longevity

CondenStop® is based on a polyester non-woven fleece. Thermoplastic Microspheres that are bound to the fibers are expanded to create a unique engineered product with very special moisture absorbing properties.

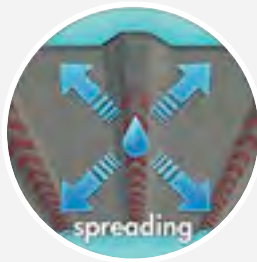

MOISTURE MANAGEMENT

The very large internal surface and tailored distribution of pores, create the special characteristics that are critical for quick absorption and moisture spread over the surface. With its large absorption capacity and controlled moisture release through evaporation, CondenStop® is the ideal product to prevent dripping or sweating of metal roofs.

SUPERIOR PERFORMANCE

CondenStop® outperforms competition by 20-60% in absorption performance. Where generic products reach their Point of Failure at typical roof pitches, CondenStop® continues to protect your roof, construction and investments.

TEMPERATURE CONTROL

Independent research has proven CondenStop® reduces interior temperature significantly during hot weather

10 REASONS TO CHOOSE CONDENSTOP®

- Highest absorption of condensation moist available
- Installation possible in all weather conditions
- Helps fight corrosion
- High fire safety classes
- Impervious to mold growth
- Does not attract dust or dirt
- Homogeneous distribution of condensation on roof surface
- Drip-free performance
- One solution for all conditions
- Over 20 years experience with condensation protection

Ventilation Is Important!

For optimal performance of CondenStop® sufficient ventilation within the building envelope is important.

AIR FLOW AND TEMPERATURE

The air flow movement and temperature within the building structure, will determine how quickly the CondenStop® will return to its original dry state. To prevent excess build-up of condensation, natural ventilation provided by eave, ridge, and wall openings plays an essential role.

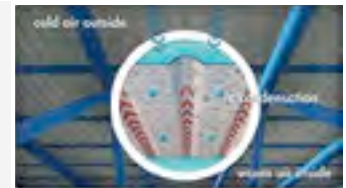

Condensation cycle



Absorption during night time



Ventilation is the key for this application



Drying by ventilation and sunlight radiation

• Residential • Agricultural • Commercial

Infinity Shield™ — Double Bubble Wrap



Infinity Shield™ is not only extremely cost efficient, but it is also incredibly hassle-free. With Infinity Shield™, you won't need to worry about the foil compressing, collapsing or disintegrating, and our ultra-white bubble will provide an impressive opaque finish.



Tape for Seams

Noteworthy Benefits:

- **Energy Efficient:** Reflects radiant heat reducing heat gain and loss
- **Reduces Condensation**
- **Labor/Time Saving:**
Lightweight and easy to handle
Fast and easy installation
Standard 2-inch crushed edge tab
- **Cost Reducing:** Reduces energy costs year-round
- **Durable:** Puncture and tear resistant
- **Made in the U.S.A.**
- **Sold by the roll:** 4' & 6' Wide x 125' L

NOTE: 2" crushed edge tab provides additional 2" to roll width

RoloShield™ 50 Synthetic Roofing Underlayment



- The most slip-resistant in the industry
- 10X lighter per square than 30# felt
- 20 times stronger than felt
- 50 year warranty

- UV resistant and can be exposed for up to 6 months when nailed with plastic roof cap nails
- Pre-printed nailing pattern
- Sold by the roll — RoloShield™ 50

Also Available: **RoloShield™ Lifetime** • Limited Lifetime Warranty

Alco Shield™ High Temperature Ice & Water Protector

Designed to be used under standing seam metal roofing, metal shingles and metal roof panels, Alco Shield™ HT Ice and Water Protector protects roofing structures against water from wind driven rain or ice dams. Made of a polymer modified asphalt membrane, it is reinforced with fiberglass for a smooth, skid resistance surface.

Limitations:

Should not be applied over shingles or underlayment of any sort

Should not be applied over damp surfaces

Should not be left exposed to sunlight for more than 90 days

CAUTION!! Surface can be slippery if wet or covered with frost



- High temperature resistance of 240° F
- Installs in most hot weather conditions
- Meets or exceeds industry standards and residential/commercial codes (ASTM D-1970)
- Self sealing: seals around nails, staples and screws
- Self-adhering: bonds directly to the roof substrate
- Excellent for under metal, slate or tile
- Made in the USA; 1.95 SQ per roll
Alco Shield™ HT Roll: 36" W x 65' L

Phone 814-349-5050 Fax 814-349-5051

SLIDING DOORS

Round Track #11 Slotted

Full round track is backed by a lifetime warranty, assuring years of quality operation. The 14 gauge galvanized construction will hold up to 600 pounds on single truck Delrin trolleys and 1,200 pounds on double truck trolleys. The slotted keyway design (#11 track) is spaced 24" O.C. and allows for multiple bracket applications, making it one of the most versatile models available.

- Available in 6', 8', 10', 12', 14', 16', 18', and 20' lengths.

Brackets sold separately for single and double track runs.



Track Splicer



#11 Slotted

Round track splice collar for use with #11 slotted track.

Track Bracket



No Cover

Small face mount bracket

Track Bracket



For Cover

This slide-on bracket face mounts and supports cover; for use with #11 slotted track.

Track End Cap



11-EB End Blind

Round track end blind with mounting bolt for use with #11 slotted track.

Double Track Bracket — No Cover



Double Track Bracket — For Cover



Bolt Package
(2 Bolt Pens)

Double Loop Track Bracket



Face mounted heavy duty double bracket for bypass installation; for use with #11 slotted track.

• Residential • Agricultural • Commercial

Delrin Wheel Trolleys/Hangers

Apron Trolley

- Adjustable, pivot & swing action
- Single strap apron
- For doors 1 1/2" to 2 3/8" thick
- Includes six 5/16" carriage bolts per pair
- Delrin wheels with ball bearings.



Bolt Trolley

- 1/2" x 9" offset bolt
- Uses Western's original girt clip.
- Generous vertical adjustment accommodates a variety of door materials
- Delrin wheels with ball bearings.



Jamb Latch



7" Jamb Latch/Snugger

- Used on the inside of jamb to secure sliding doors
- Used for either right or left hand applications
- Strike plate is lumber-fit for easy installation

Center Door Latch



Easily & Tightly Secures Bi-Parting Doors

- Cam-action latch
- Strong bolt hooks at one end to fit strike plate
- Opposite end is threaded to allow adjustment of latch tension.
- For wood doors 1 1/2" or thicker

Sliding Bolt Latch



Ideal for Livestock/Horse Barns

- Heavy duty 1/2" x 10" steel bolt doubles as a handle/pull
- May be latched at left or right
- Mounting screws and installation guide included

Chain Snugger

For Bi-Parting Doors

- Ring and hook simply secure a chain to desired length
- Designed for use with clad wood-frame doors.



Cane Bolt

18" & 24"

- Zinc plated
- Fancy mounting brackets and screws included.
- 1/2" diameter x 18" long rod
- 5/8" diameter x 24" long rod

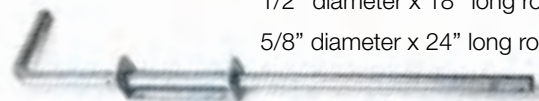

SLIDING DOORS

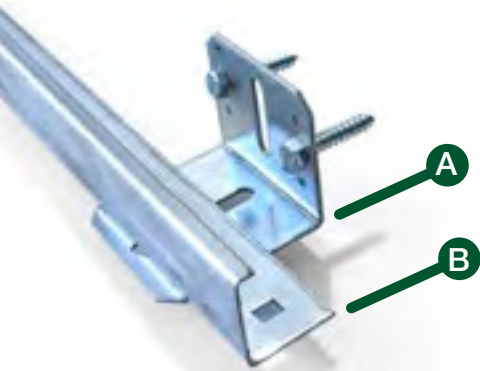

Guide Rail

A. #60 Guide Rail Bracket

- For use with #64 Guide Rail
- Slotted hole in each leg allows both lateral and vertical adjustments
- Bolts and nuts included.

B. #64 Guide Rail

- Mounts with #60 brackets
- 16 gauge galvanized steel
- Engages the bottom door guides to hold the door in place and prevent wind damage
- Available in 5' and 10' lengths

Door Pull



- 1 1/4" wide x 6 5/8" overall length
- 1 3/4" deep clearance to allow use with gloved hand

Stay Roller



Heavy Duty Stay Roller

- Fabricated from 3/16" zinc plated steel
- Adjust for doors 1" to 3 3/4" thick.
- 2" non-marking plastic wheel is mounted on a sturdy 1/2" bolt.

Center Guide/Stop



- For Single Slide or Bi-Parting Metal or Wood Doors
- Mounts on concrete floor with lag screws and shields or on a 6" x 6" post
- To turn into a door stop: install "L" bracket along with the "Z" bracket.
- Fasteners for mounting not included

Door Binder/Stop



For 2" doors

- Rugged zinc plated steel
- Ribbed to increase strength
- Holes accept 5/16" bolts or lag screws (not included).

Adjustable Door Stop



- Made for doors up to 4 1/4" thick

Jamb Mount Door Stop



Extends from Jamb

- 2 1/2" x 8 1/2" galvanized steel
- Stop and hold doors in open or closed position

• Residential • Agricultural • Commercial

1 1/2" Sliding Door Frame

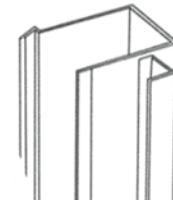
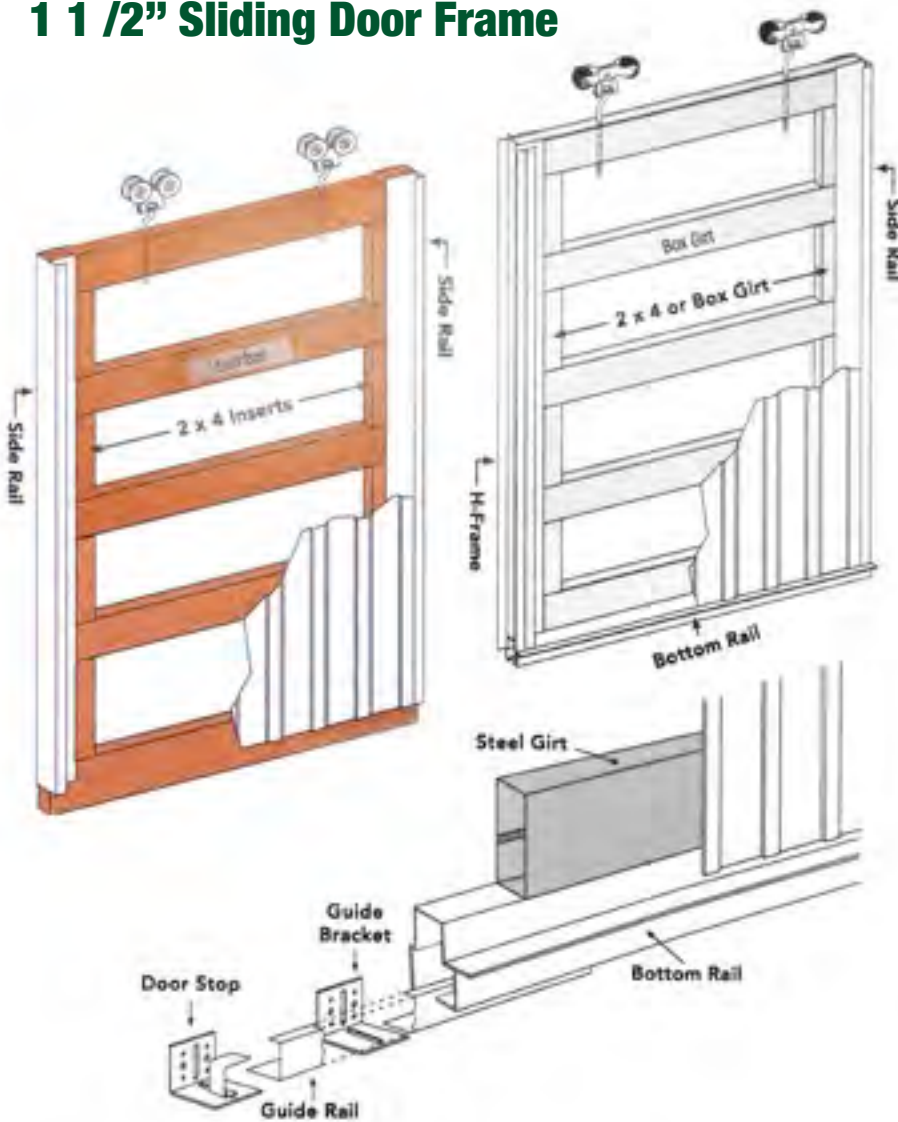

Door Frame Side Rail

- Fits standard 2 x 4 or 2 x 6 lumber
- Provides smooth, safe sides for door openings
- Available in 8', 10', 12', 14', and 16' lengths

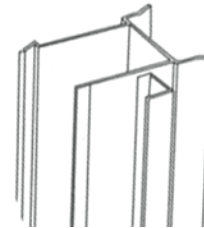

Door H-Frame Connector Rail

- Designed for use with bi-parting doors
- Provides concealed mating between units covering both door edges
- Available in 8', 10', 12', 14', and 16' lengths

1005 Bottom Rail

- Mounts on face of wood bottom rail
- Provides smooth surface for a stay roller
- Available in 8', 10', 12', 14', 16', 18', and 20' lengths

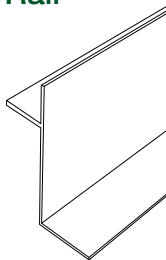

1003 & 2003* Bottom Rail

- Accepts the #64 Rail Guide to firmly anchor and guide door along building during operation.
- Attaches to bottom of 1 1/2" thick doors
- Available in 8', 10', 12', 14', 16', 18', and 20' lengths

1003

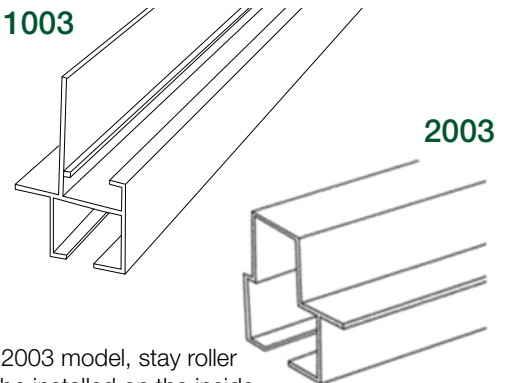

*On 2003 model, stay roller can be installed on the inside

SNOW GUARDS

Metal Roofing Snow Guards

Easy and Quick to Install

- 16 gauge type 304 stainless steel
- Rubber sealer—no need to caulk
- Powder coated or mill finish
- Made in USA



Manufacturer Of Quality Metal Roofing

6278 Brush Valley Rd • Rebersburg, PA 16872

Service & Quality

Solid Ridge Metal LLC is locally owned and operated in central PA. High attention to detail and quality is part of our daily routine. Whether you are in need of metal panels, lumber, fasteners, trim, or accessories, they can all be found at our manufacturing facility.

©2021 All rights reserved

***Please Ask for a Brochure Showing
Metal Color Swatches and Trim Accessory Profiles***

CONTACT US FOR YOUR METAL ROOFING & SIDING NEEDS!

Phone 814-349-5050 Fax 814-349-5051